

UHF427VM Series

UHF vehicle whip, dipole, 0.74 m, 450–2690 MHz

Tactical Antennas: Tactical and Base Station

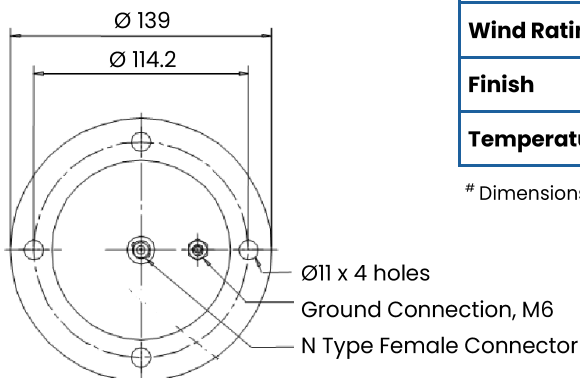
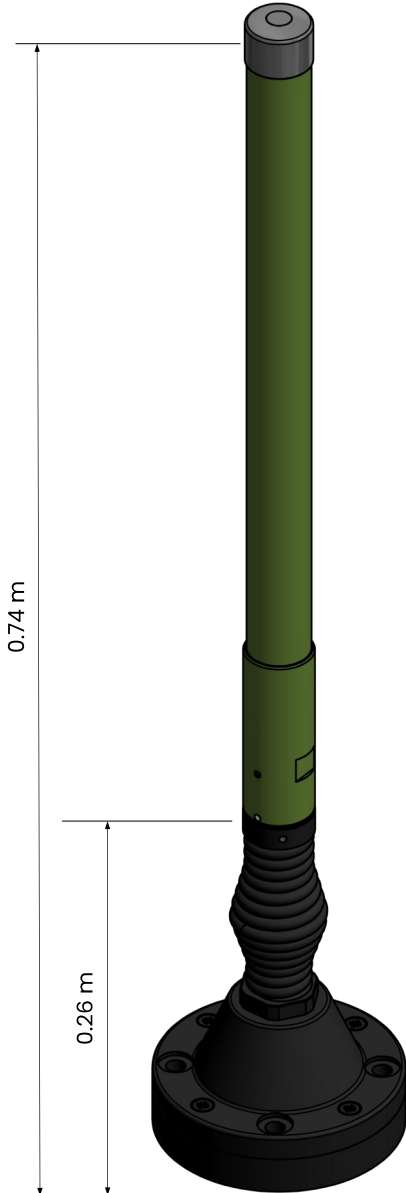

Features

- 450–2700 MHz (covers multiple LTE bands)
- Single connector
- Designed for operation on all military and civilian platforms
- Designed for operation on shelters, mounted on masts or in other permanent installations
- Rugged high quality antenna with a durable construction
- NATO flange base with spring. Base options available including vehicle/shelter, mast mount and GPS

Electrical Specifications

Frequency Range	450–2700 MHz Optimised for 450–470, 698–960, 1710–2690 MHz
VSWR	<3.5:1 Typical, 4:1 max
Nominal Impedance	50 Ω
Power Rating	20 W CW
Gain	See curve overleaf
Radiation Pattern	Omnidirectional
Polarisation	Vertical
Connector	N Type Female (others on request)

Electrical Specifications

Design	Radiating elements completely enclosed in epoxy/fibreglass laminate. Metal parts are brass, aluminium and stainless steel.
Length[#]	74 cm, with spring base
Weight[#]	Whip: 0.8 kg Base: 1.8 kg
Wind Rating	55m/s (201 km/h)
Finish	Polyurethane lacquer
Temperature Range	- 55°C to + 71°C

[#] Dimensions and weights for standard 4-hole vehicle mounted version

Plots

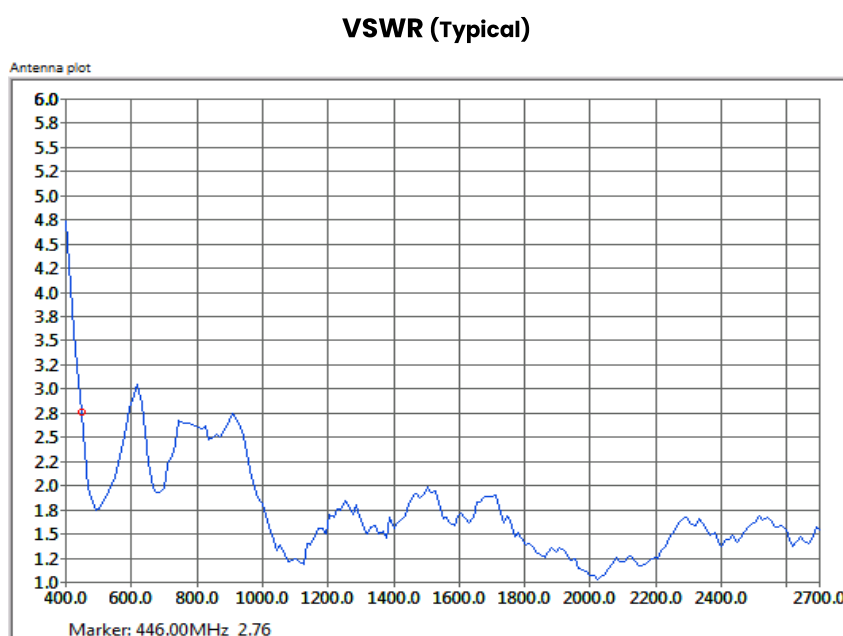
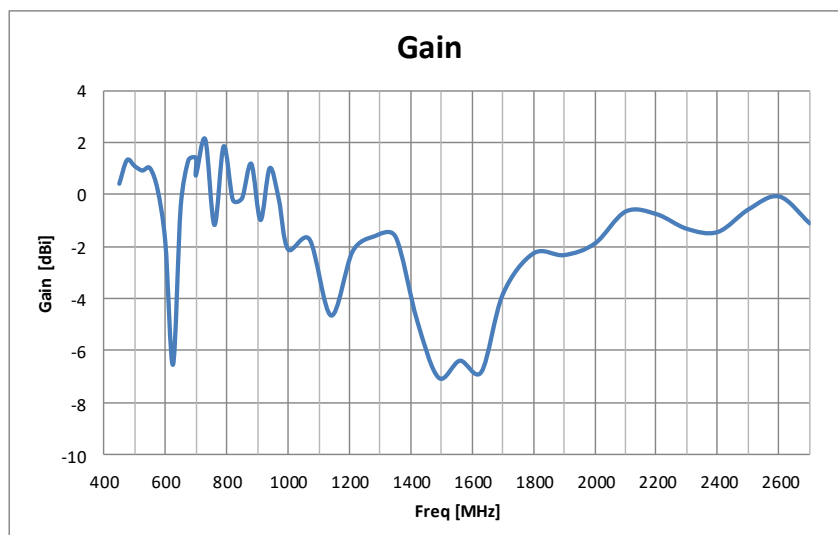

Base Options



A

NATO 4-hole
4 x M10 or 3/8" Bolts
on 114 mm PCD
Base diameter 140 mm

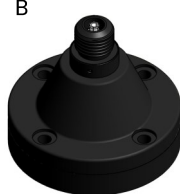

B

NATO 4-hole
Rigid (no spring)
4 x M10 or 3/8" Bolts
on 114 mm PCD
Base diameter 140 mm



C

NATO
50 mm Thread
Base diameter 95 mm



D

Mast Mount Bracket
Rigid (no spring)
24 mm Spigot
50 mm Spigot
Customer Specified



E

Tube Clamp Adaptor
Clamp area diameter 38 mm
Clamp area length 80 mm
N-type female bottom
connector

Antenna Variants

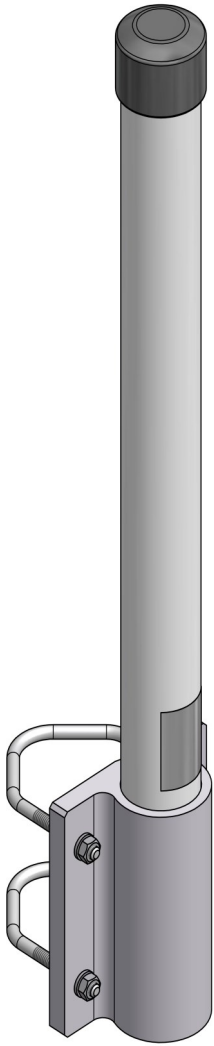

A permanent mast mount version is also available.
(Part No. UHF427M)
N type female connector
Supplied with U-bolts to fit pole size \varnothing 25-65 mm

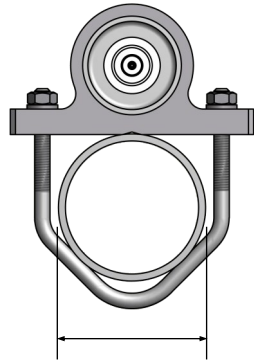

Mounting pole diameter
25-65 mm

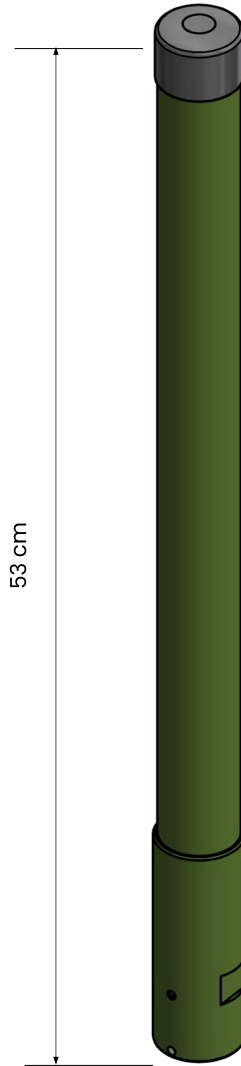

Typical mast mounted version supplied with mast mounting bracket (\varnothing 24 mm spigot version shown)

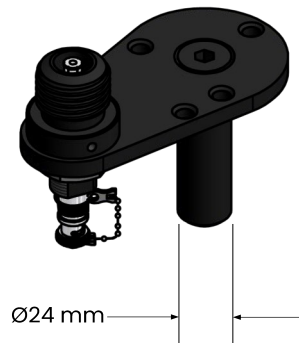

\varnothing 24 mm

September 2018

All specifications are subject to change without notice
The information contained herein is for reference only and does not constitute a warranty of performance

Partnered Supplier



sales@eylex.com.au
www.eylex.com.au

